

PARTS

Text

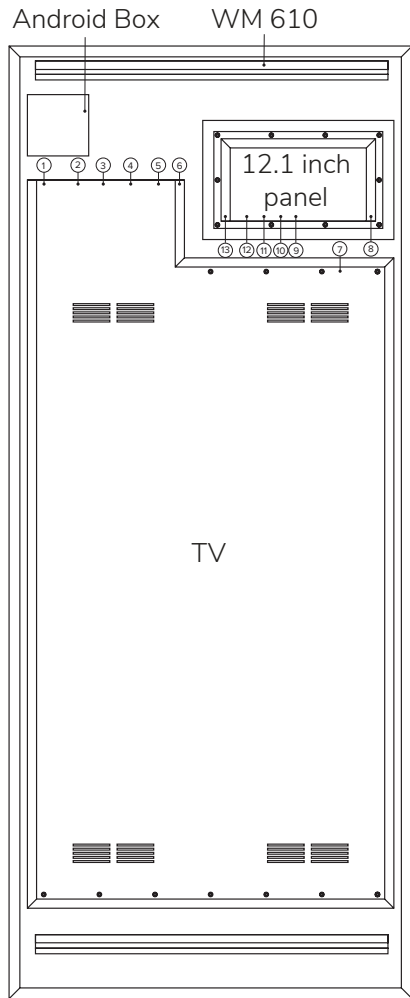

- ① Power Input
- ② Touch Screen
- ③ Microphone
- ④ HDMI
- ⑤ USB
- ⑥ Output 12v
- ⑦ Output 12v
- ⑧ IR
- ⑨ LAN
- ⑩ USB
- ⑪ Remote
- ⑫ SD
- ⑬ Power Input

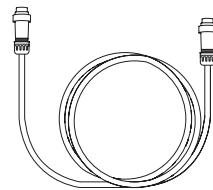

Extension Cord

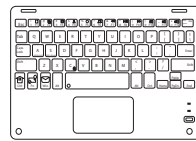

Keyboard



Smart Remote Control

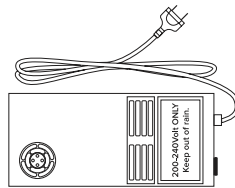

Power Supply



Evervue Remote



WM 610

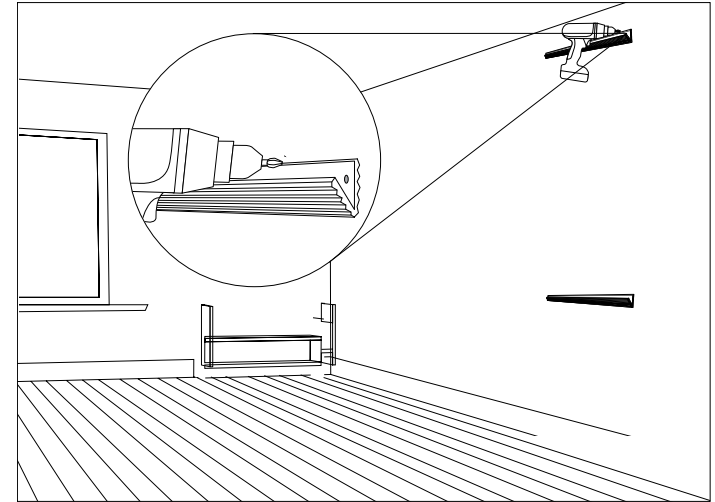

2 Screw the wall mounts to the wall.

1 Upon receiving your order, open the crate and inspect the content. Damages must be reported within 24 hours.

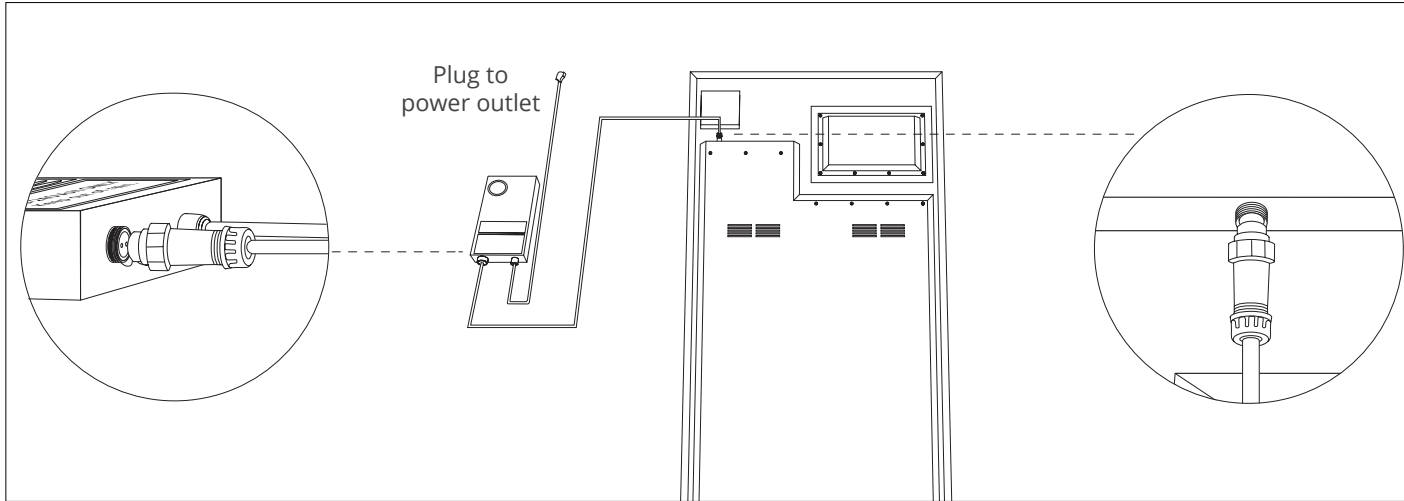

3 Connect the mirror to the power supply.

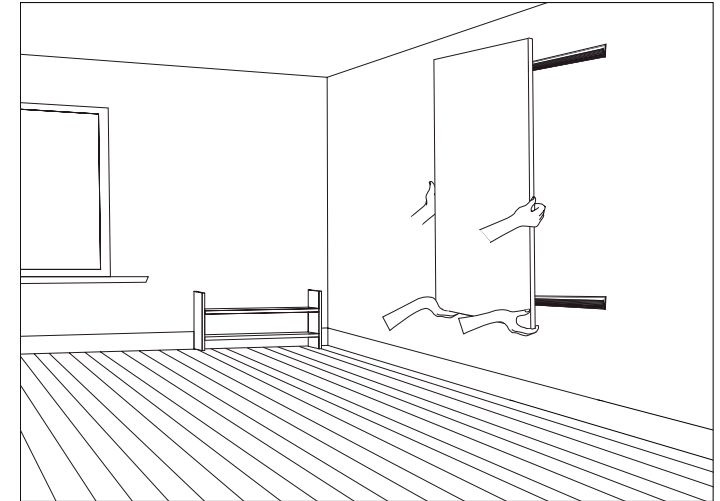

4 Securely engage the brackets at the back of the mirror to the brackets installed on the wall.

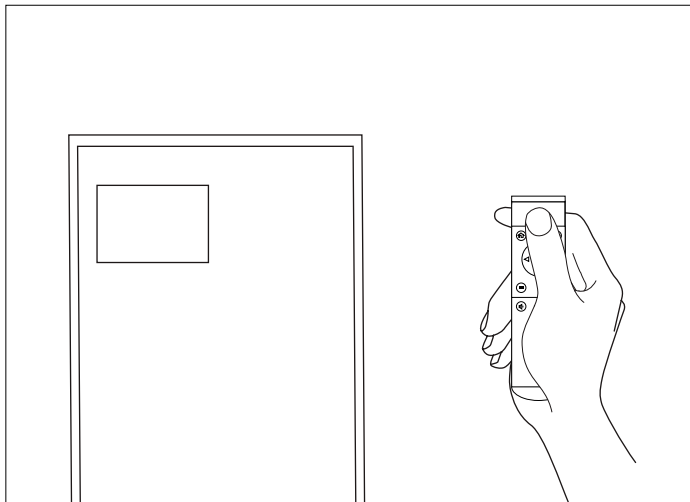

5 Turn on the the 12.1 inch panel by pressing the power button on the smart TV remote.

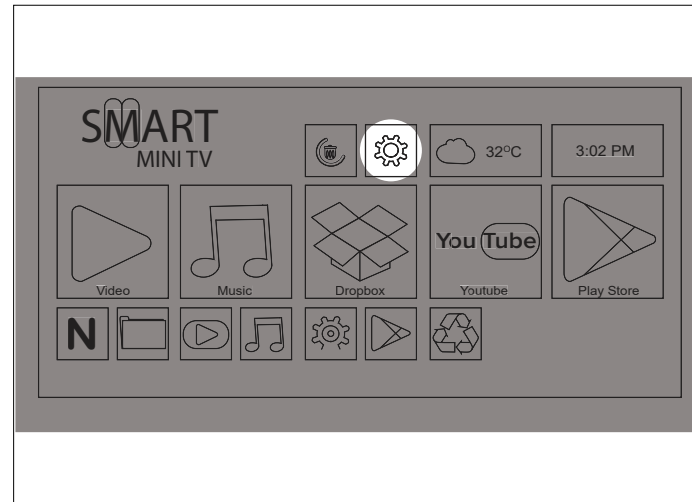

6 Once the screen is on. Click on the icon that looks like a gear. This will open the up the settings menu where you can connect to the internet.

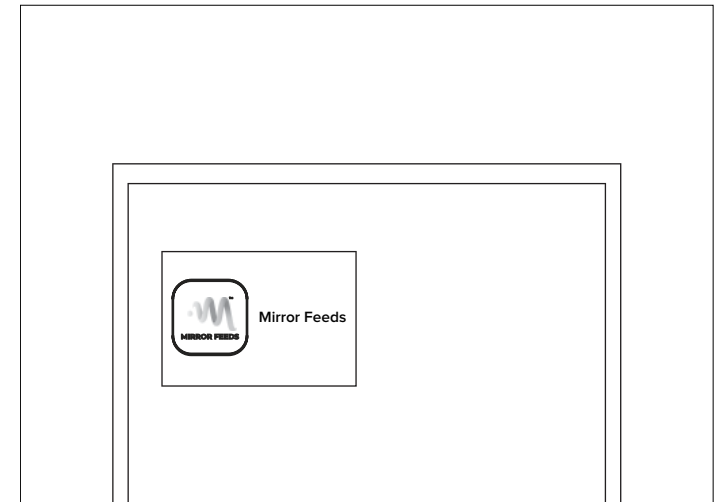

7 Go to the QAIO website, download the mirror feeds app, and install it on your mirror. For a more in-depth guide please see the mirrorfeeds manual on the Help center of the QAIO website.

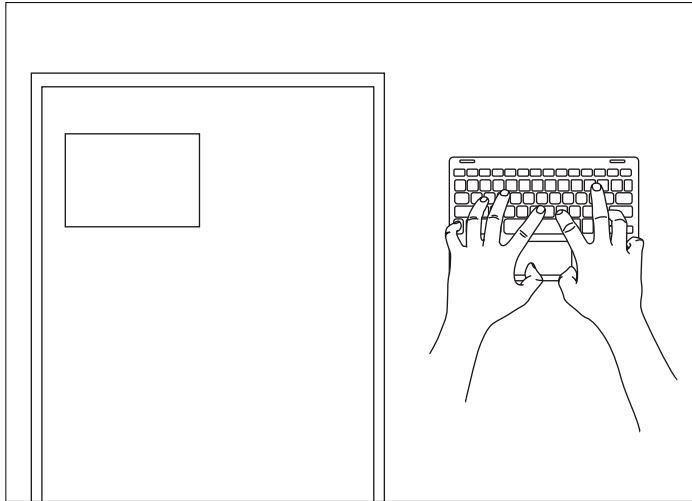

8 Navigate with the wireless keyboard or directly on the mirror to download and manage apps.

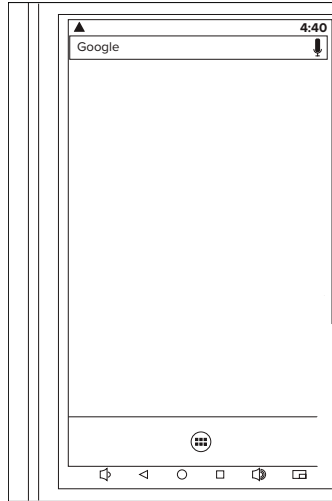

9 Turn the Smart TV by pressing the power button on the TV remote.

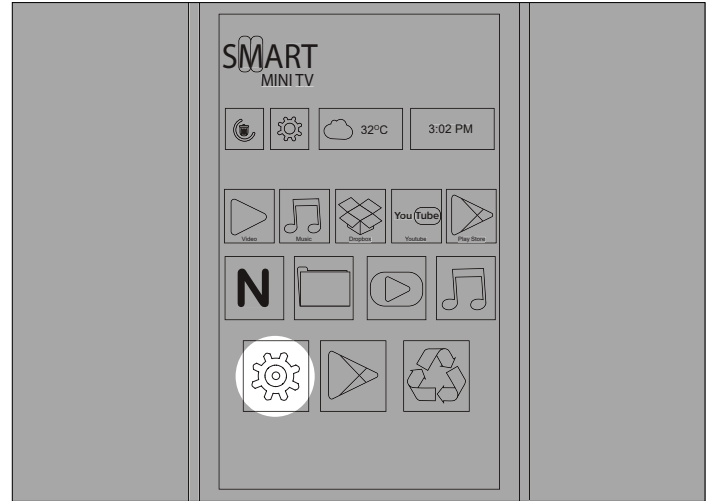
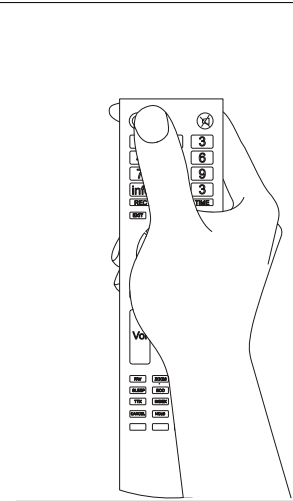

10 Go to settings and connect to the internet.

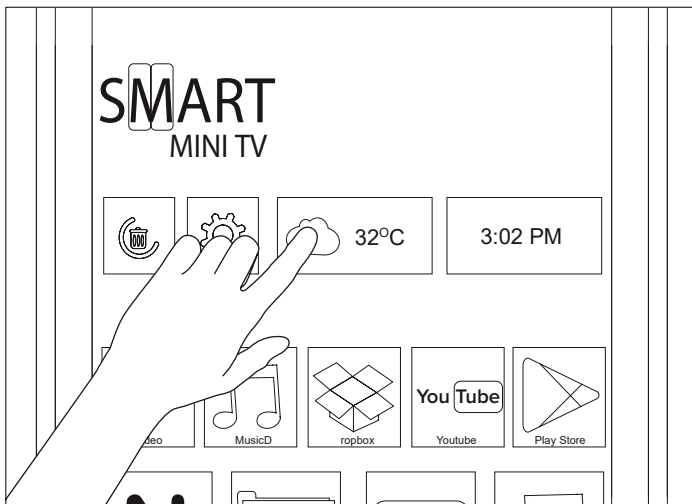

11 Manage and control the mirror directly with its touch screen feature.

QAIO Flex (Wall Mount) Application Setup

OPTION 1: Download the application from the Play Store.

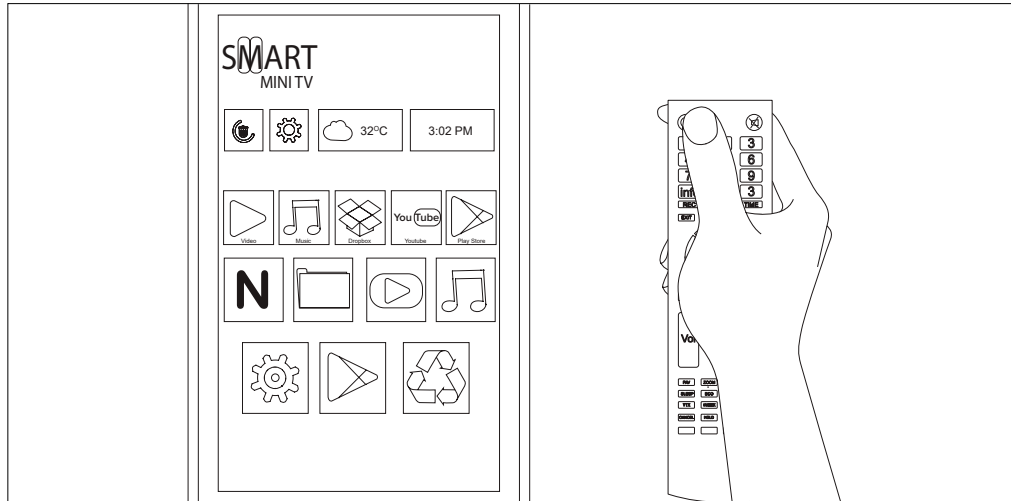

1 Turn the Smart TV on by pressing the power button on the TV remote.



2 Go to Play Store.

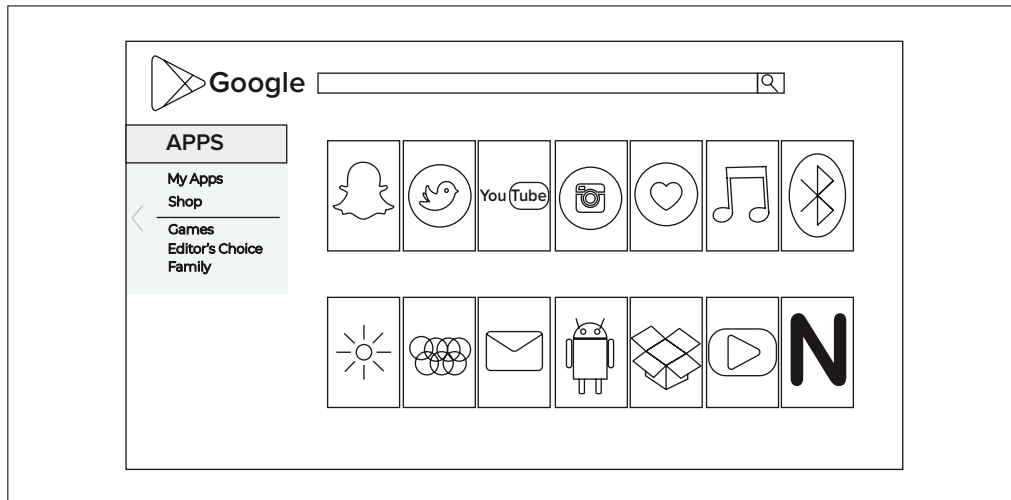

3 Search for the app you wish to install.

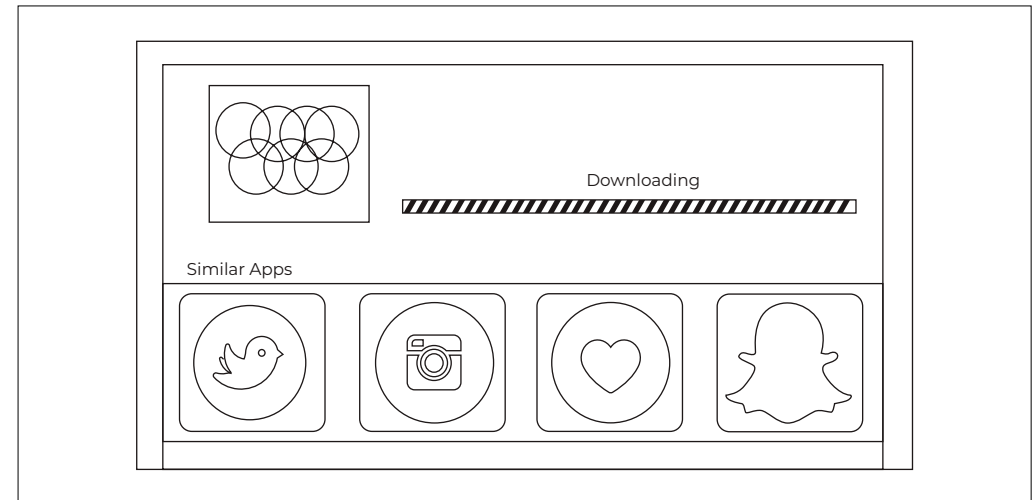

4 Click install and wait for it to finish downloading.

OPTION 1: Download and install APK of the application.

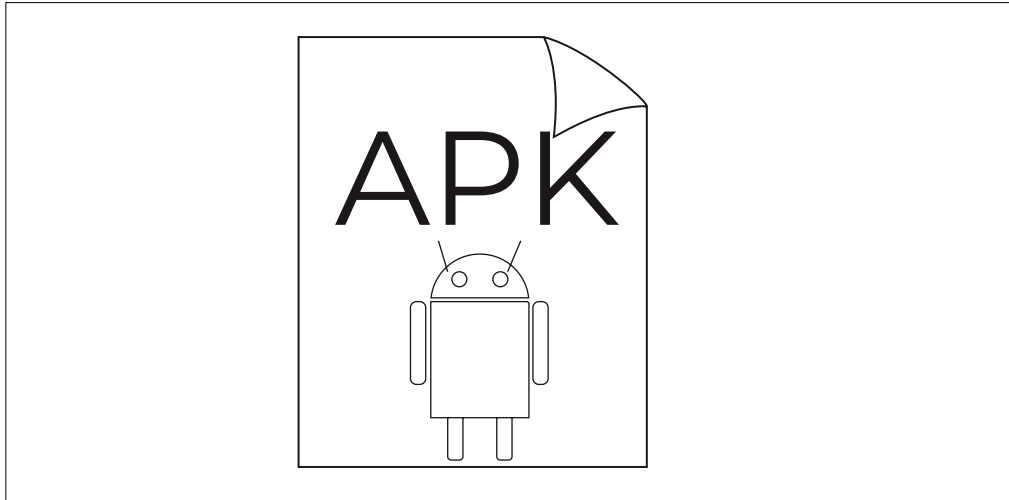

1 Find and download the APK of your desired application online.



2 Once the download is complete. Go to file manager and find the APK you downloaded. Click it and it will be installed.